

SmartGPS

Version 2.0



LXNAV d.o.o. • Kidričeva 24, 3000 Celje, Slovenia • tel +386 592 33 400 fax +386 599 33 522
marine@lxnav.com • marine.lxnav.com

1	Important Notices	3
1.1	Limited Warranty	3
1.2	Packing Lists	4
2	Technical Data	5
2.1	General specifications	5
2.2	NMEA2000 specifications	5
2.3	GNSS characteristics	6
3	Product specification	7
3.1	NMEA2000 M12 connector pinout	7
4	Information and Installation	8
5	Connecting to the SmartGPS Antenna	9
5.1	Connect the SmartGPS Antenna to the chartplotter	9
5.2	Connect to the SmartGPS platform	9
6	SmartGPS platform	10
6.1	Settings	10
6.2	Home page	11
6.3	Vessels	12
6.4	Logbook	13
6.5	Favourites	15
6.6	Warnings	16
7	Supported data	17
8	Revision history	18

1 Important Notices

Information in this document is subject to change without notice. LXNAV reserves the right to change or improve their products and to make changes in the content of this material without obligation to notify any person or organization of such changes or improvements.



A Yellow triangle is shown for parts of the manual which should be read very carefully.



Notes with a red triangle describe procedures which are critical and may result in loss of data or any other critical situation.



A bulb icon is shown when a useful hint is provided to the reader.

1.1 Limited Warranty

The SmartGPS product is warranted to be free from defects in materials or workmanship for two years from the date of purchase. Within this period, LXNAV will, at its sole option, repair or replace any components that fail in normal use. Such repairs or replacement will be made at no charge to the customer for parts and labour, provided that the customer pays for shipping costs. This warranty does not cover failures due to abuse, misuse, accident, or unauthorized alterations or repairs.

THE WARRANTIES AND REMEDIES CONTAINED HEREIN ARE EXCLUSIVE AND IN LIEU OF ALL OTHER WARRANTIES EXPRESSED OR IMPLIED OR STATUTORY, INCLUDING ANY LIABILITY ARISING UNDER ANY WARRANTY OF MERCHANTABILITY OR FITNESS FOR A PARTICULAR PURPOSE, STATUTORY OR OTHERWISE. THIS WARRANTY GIVES YOU SPECIFIC LEGAL RIGHTS, WHICH MAY VARY FROM STATE TO STATE.

IN NO EVENT SHALL LXNAV BE LIABLE FOR ANY INCIDENTAL, SPECIAL, INDIRECT OR CONSEQUENTIAL DAMAGES, WHETHER RESULTING FROM THE USE, MISUSE, OR INABILITY TO USE THIS PRODUCT OR FROM DEFECTS IN THE PRODUCT.

Some states do not allow the exclusion of incidental or consequential damages, so the above limitations may not apply to you. LXNAV retains the exclusive right to repair or replace the unit or software, or to offer a full refund of the purchase price, at its sole discretion. SUCH REMEDY SHALL BE YOUR SOLE AND EXCLUSIVE REMEDY FOR ANY BREACH OF WARRANTY.

To obtain warranty service, contact your local LXNAV dealer or contact LXNAV directly.

1.2 Packing Lists

- 1x SmartGPS unit

2 Technical Data

2.1 General specifications

Parameter	Condition	Min	Typ	Max	Unit
Absolute maximum supply voltage ⁽¹⁾		-35V		35	V
Operating supply voltage	Recommended	8	12	28	V
Current consumption	@8V	60	150	230	mA
	@12V	40	120	180	mA
	@24V	30	50	80	mA
Load equivalent number	@8V	2	3	5	LEN
	@12V	1	3	4	LEN
	@24V	1	1	2	LEN
Operating temperature		-20		+65	°C
Storage temperature		-40		+85	°C
Weight		130			g
Dimensions L x W x H		120	70	36	mm
Ingress protection		IP40			
Position accuracy		4		2.5	m

Note1: Voltages outside of this range may permanently damage the device

Table 1: General specifications

2.2 NMEA2000 specifications

Parameter	description
Compatibility	NMEA2000 compatible
Bit rate	250kbps
Connection	A coded M12 connector

Note1: Supplied via M12 NMEA2000 connector

Table 2: NMEA2000 specifications

2.3 GNSS characteristics

Parameter	Value	Unit
Position accuracy	2.5-4	m
Time to first fix	90	s

Table 3: GNSS characteristics

3 Product specification



3.1 NMEA2000 M12 connector pinout

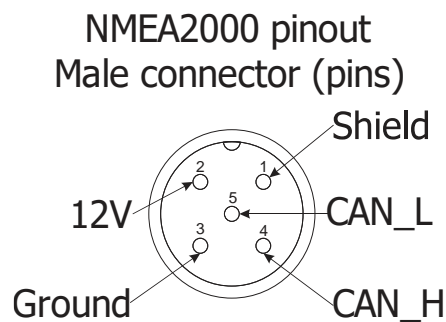

Figure 1: NMEA2000 M12 Male connector pinout (view from unit side)

4 Information and Installation

General:

The SmartGPS is tracking device which also functions as a NMEA2000 compatible GPS antenna.

It has been designed to track small marine vessels. Each device can be used to track a single vessel. Each vessel's position and other NMEA2000 parameters (depending on technical support and user settings) are sent to LXNAV's SmartGPS Web Platform, where the collected data can be visualized. In order for the system to fully function, each device must be connected to a user account on the SmartGPS Web Platform, and the user account must have a valid data plan (for information on available data plans, please contact: marine@lxnav.com).

The device can however still function as a NMEA2000 GPS antenna without the device being connected to a SmartGPS Web Platform account or a valid data plan.

The device requires no maintenance; calibration of the internal antenna has been performed by the manufacturer.

Connecting to the NMEA2000:

To perform, the SmartGPS must be connected to the vessel's NMEA2000 backbone to be powered up by the N2k network.

Once connected, the device will start reporting the position and the NMEA2000 parameters to the SmartGPS online platform.

Mounting recommendations:

The housing of the device should be mounted on a flat and solid surface with clear view to the sky. Avoid placing the device to any strong RF transmitting devices (antennas) to minimize interferences. Unit can be fixed through the mounting hole with diameter of 2 mm.



Do not place the device in an area where it may be flooded. Avoid areas where the SmartGPS can be exposed to unintentional impact.

To avoid possible personal injury, always wear safety equipment when installing, drilling or cutting.

5 Connecting to the SmartGPS Antenna

5.1 Connect the SmartGPS Antenna to the chartplotter

Once connected to the N2k backbone, the user can set the SmartGPS as the primary GPS antenna source with any compatible chartplotter by selecting the device in the settings under NMEA2000 data source.

E.g., E-Series chartplotters: Settings > Network > Data sources > GPS Antenna

5.2 Connect to the SmartGPS platform

A data plan is required to use the SmartGPS as boat tracking system with the web platform. Contact marine@lxnav.com for more information available data plans.

SmartGPS Features:

- Location is recorded every 5 seconds
- Geofence support (entering/leaving zones)
- Get alert notification
- Report of the boat parameters via the NMEA2000 network (Engine rpm, fuel consumption, battery monitoring, depth...)
- Complete log book with precise statistics
- Fleet monitoring
- Easy connection to the platform via Smartphone, tablet or computer

First steps - SmartGPS platform:

1. Create an account: <https://smartgps.lxnav.com/sign-in>
2. Once you create your account, click to the settings to add the data plan,
3. Insert the following data key to activate the plan for your account.
4. Go back to the main page and click on "Add a Vessel" section,
5. Enter the IMEI number of the SmartGPS device. (Also seen at the back of the device)
6. Name the vessel as you would like.
7. Connect the SmartGPS on the NMEA2000 network vessel and start tracking and monitoring your boat.

6 SmartGPS platform

6.1 Settings

Once the account created, the user can access to **My Account** to set the login data and reset/change the password if needed.

In the settings, the user can monitor the **Data Plan** and its expiration date. Annual subscription can be renewed by activating a new data key.

Email address for warning notification, date & time, display units can be done through the **Preferences** tab.



Initial configuration of the settings is recommended to define the alerts notifications (Warnings) and set the basic parameters such as Display units.

The screenshot displays the 'Settings' page of the lxnav SMARTGPS application. At the top left, the 'lxnav SMARTGPS' logo is visible. On the right side, there are controls for 'LIGHT' (a toggle switch) and a user profile icon with a dropdown arrow. The main content area is titled 'Settings' and features a sidebar on the left with the following menu items: 'My Account' (highlighted in yellow), 'Data Plan', 'Preferences', 'Sharing', and 'About'. The main content area is titled 'Account' and includes the subtitle 'Basic information about your account.' Below this, there are three input fields: 'Username' with the value 'Example', 'Email' with the value 'example@lxnav.com', and 'Current password' with a lock icon. A dropdown menu is open on the right side of the 'Settings' header, showing 'Settings' and 'Sign out' options.

6.2 Home page

Live tracking. The home page displays current position of the boat(s) and the live tracking information such as SOG, depth, engine RPM, Fuel rate, engine trim, engine temperature.

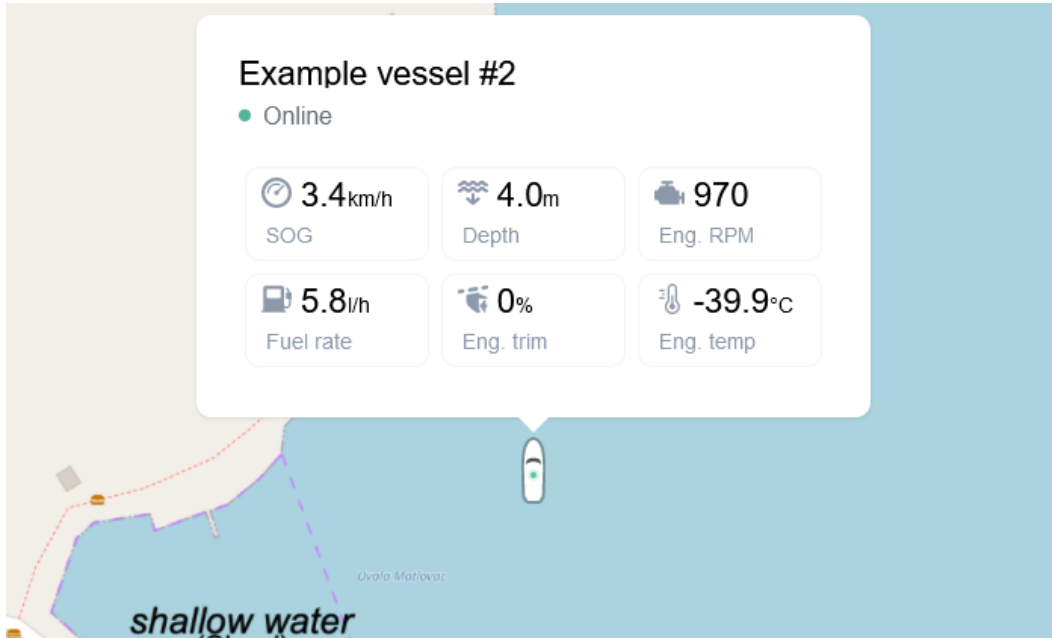

Geofencing: The user can create multiple geofences zones and set alerts in case the boat is entering or leaving a virtual area on the water. Alerts are notified via email.

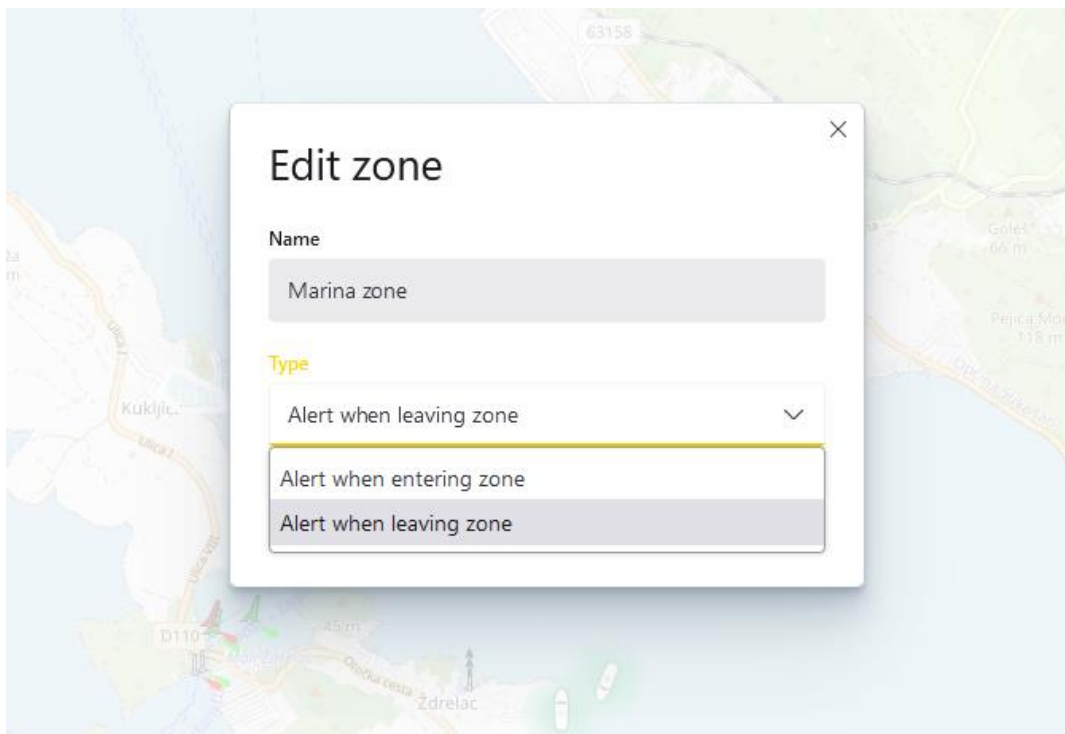

6.3 Vessels

Vessel's tab allows to monitor multiple vessels, get live information such as boat's position and connected NMEA2000 parameters. List of warnings & latest trips are also displayed.

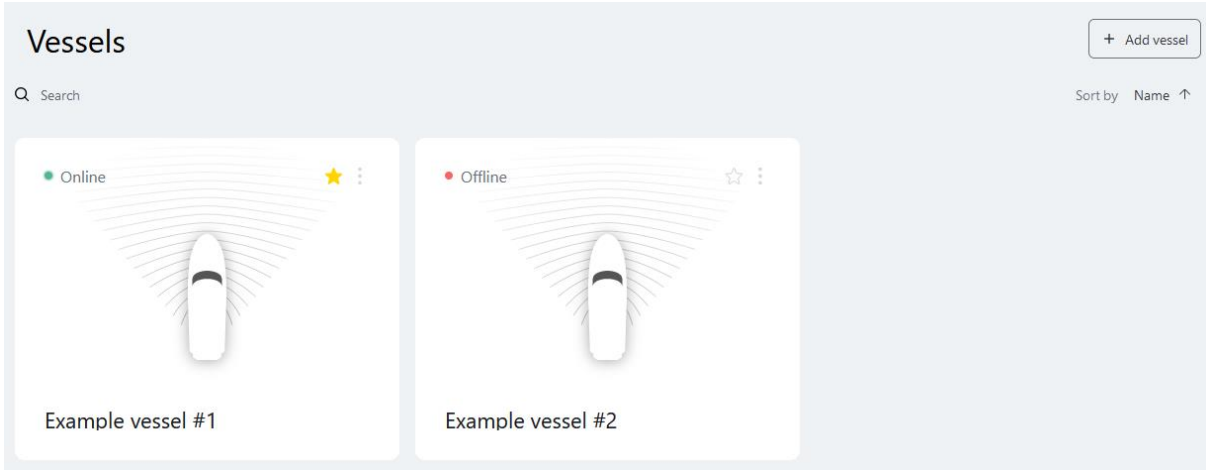

The N2K parameters can be readable configured individually.

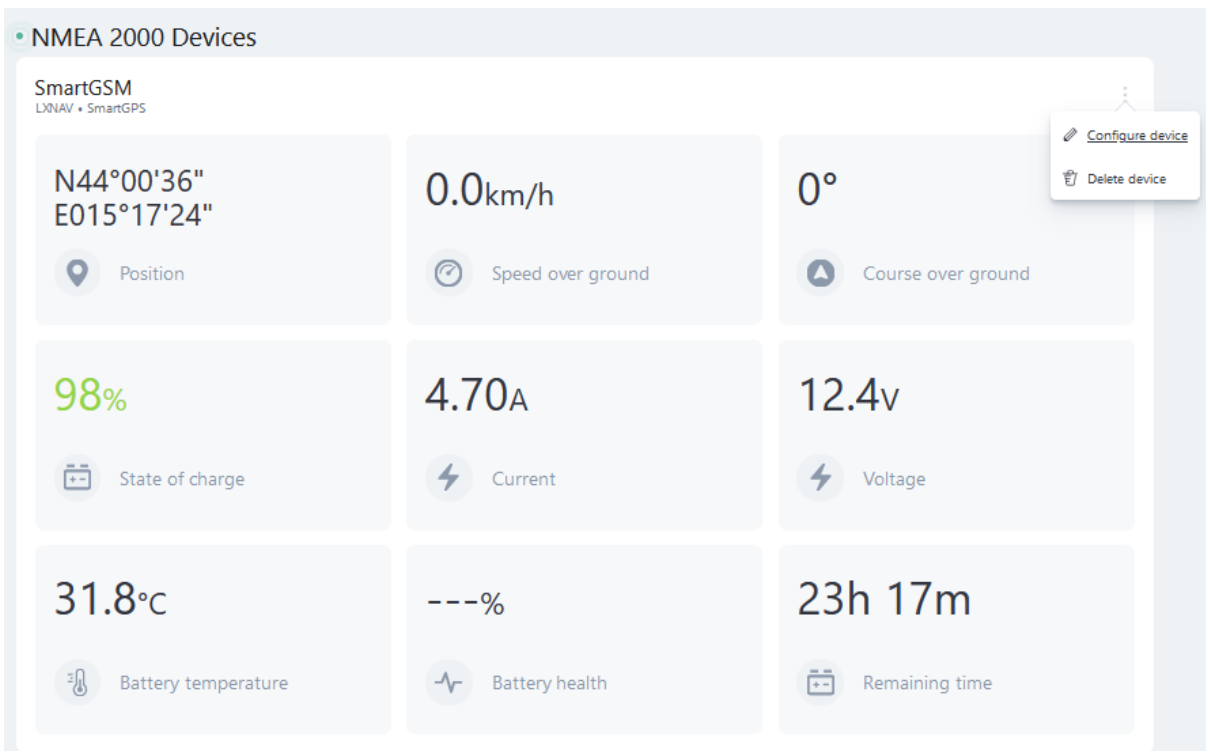

6.4 Logbook

The complete trip history of all the vessels is accessible from the **Logbook** tab. Research by vessel name & date can be done from the top menu options.

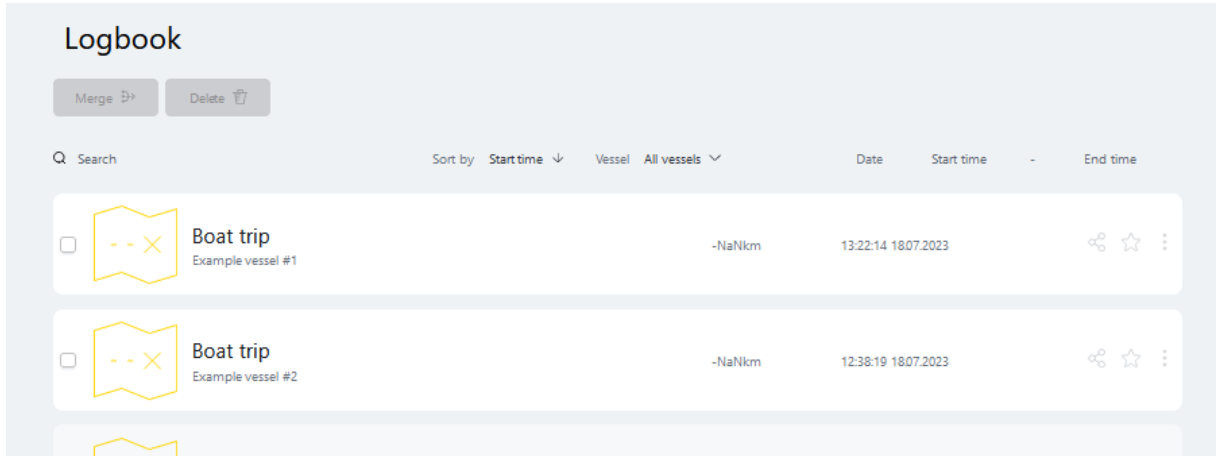

The list of warnings, complete statistics and charts are shown to have a detailed overview of the past boat trips.

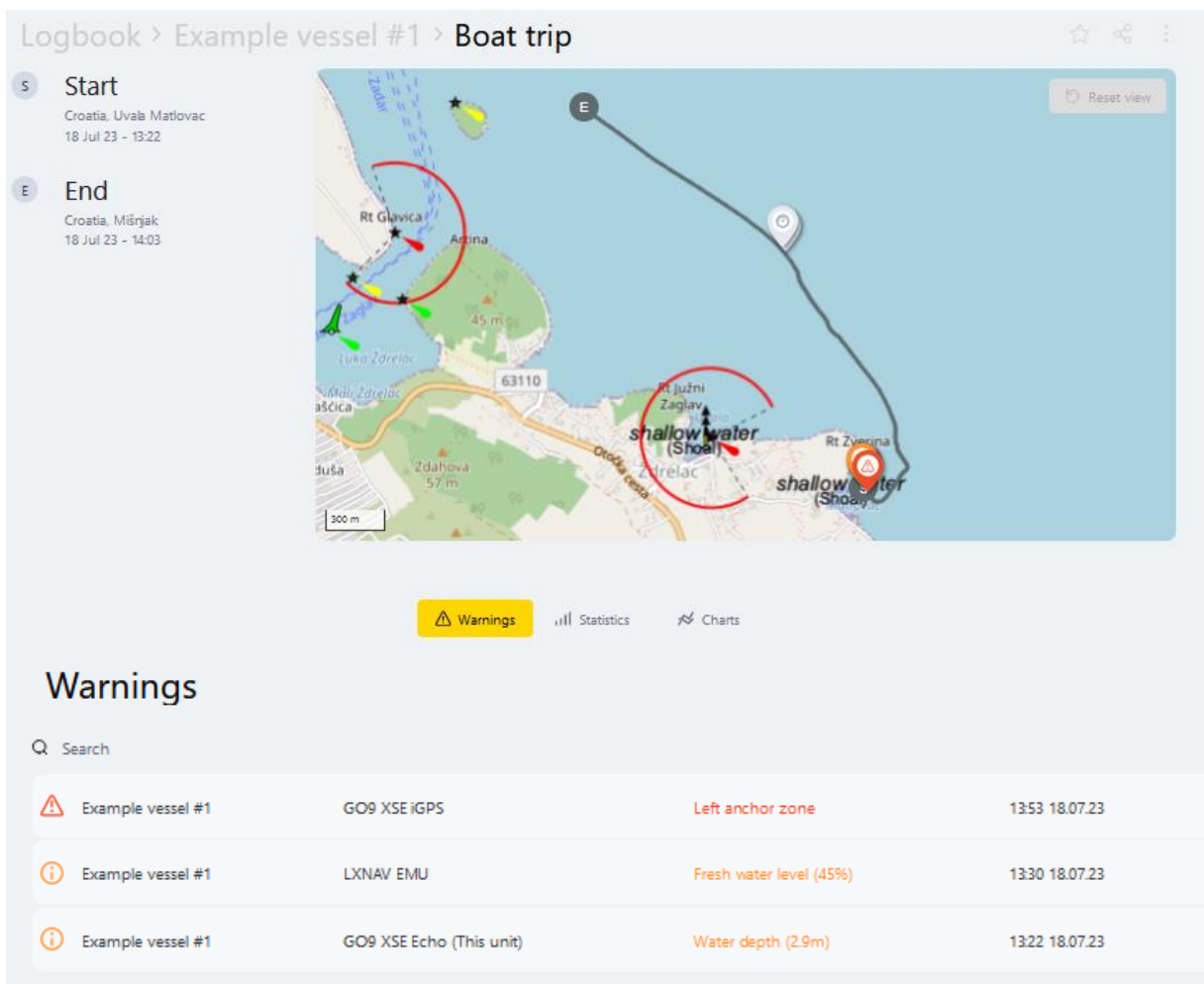

Statistics

Example vessel #1

Vessel

3630

Time 14:01

Maximum engine RPM

46km/h

Time 14:01

Maximum speed

2.6m

Time 13:53

Minimum water depth

3.2km

Distance

2.0l

Fuel used

63l/100km

Trip fuel economy

Charts

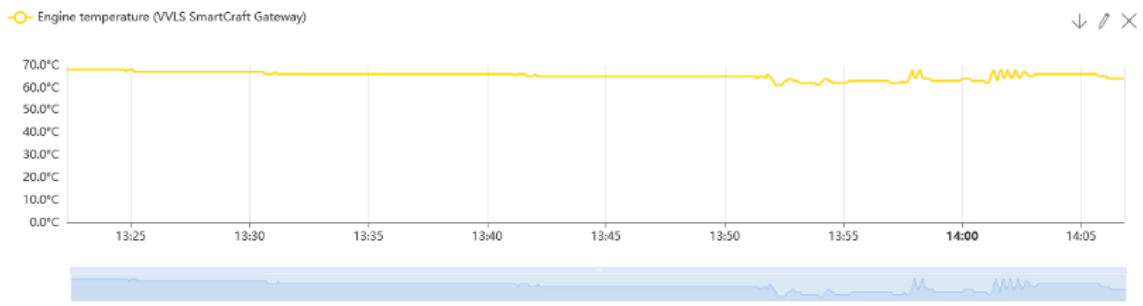
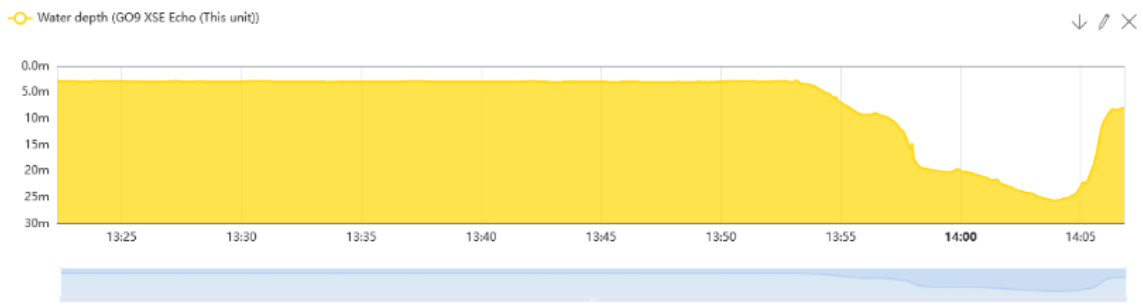
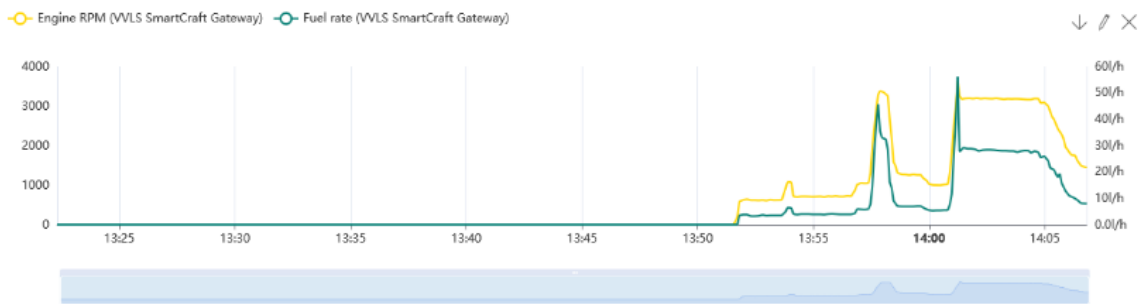

6.5 Favourites

The user can save multiple past trips the **Favourites** tab and have fast view and access on specific boats. (Convenient for fleet monitoring)

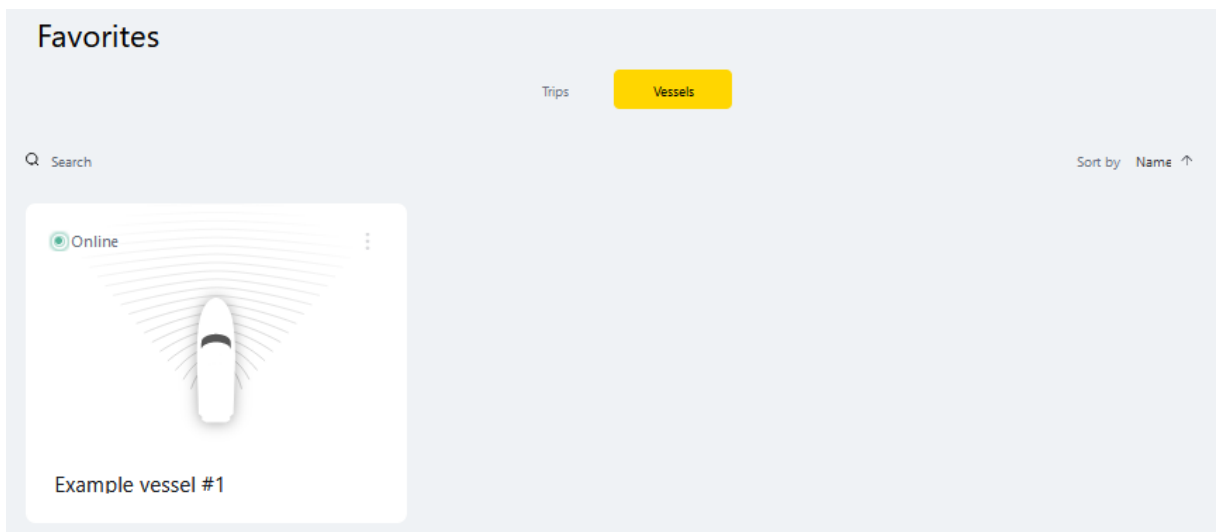
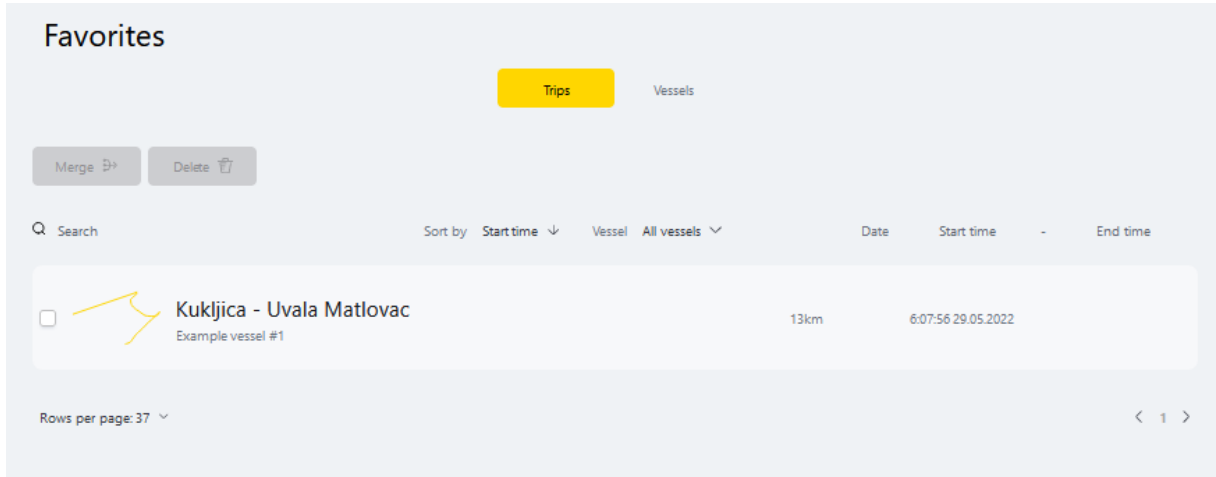

6.6 Warnings

The reported **Warnings** history helps to monitor the past incident and can be useful for inspection or maintenance of the vessels.

Warnings

☰ Dismiss All

🔍 Search
Sort by Event time ↓

⚠	Example vessel #1	GO9 XSE IGPS	Left zone "Marina"	1415 18.07.23	Dismiss ✓
⚠	Example vessel #1	GO9 XSE IGPS	Left zone "Marina"	1409 18.07.23	Dismiss ✓
ⓘ	Example vessel #1	VVLS SmartCraft Gateway	Fuel tank level (47%)	1405 18.07.23	Dismiss ✓
⚠	Example vessel #1	GO9 XSE IGPS	Left anchor zone	1353 18.07.23	Dismiss ✓
ⓘ	Example vessel #1	LXNAV EMU	Fresh water level (45%)	1330 18.07.23	Dismiss ✓
ⓘ	Example vessel #1	GO9 XSE Echo (This unit)	Water depth (2.9m)	1322 18.07.23	Dismiss ✓

Rows per page: 100 ↓
⏪ 1 ⏩

7 Supported data

NMEA 2000 compliant PGN

List NMEA 2000 PGN (transmit)

127258	Magnetic variation	1Hz
129025	Position, Rapid Update	10Hz
129026	COG & SOG, Rapid Update	10Hz
129029	GNSS Position Data	1Hz
129540	GNSS Satellites in View	1Hz

List NMEA 2000 PGN (receive)

126992	System Time
127245	Rudder
127488	Engine, Rapid Update
127489	Engine, Dynamic Update
127505	Fluid Level
127506	DC Detailed
127508	Battery Status
128259	Water Speed (Ref.)
128267	Water Depth
129025	Position, Rapid Update
129026	COG & SOG, Rapid Update
129029	GNSS Positional Data
130312 & 130311	Environmental Parameters (old)
130316	External Temperature

8 Revision history

Date	Revision	Description
September 2023	1.0	Initial release of this manual